

EL20-S458

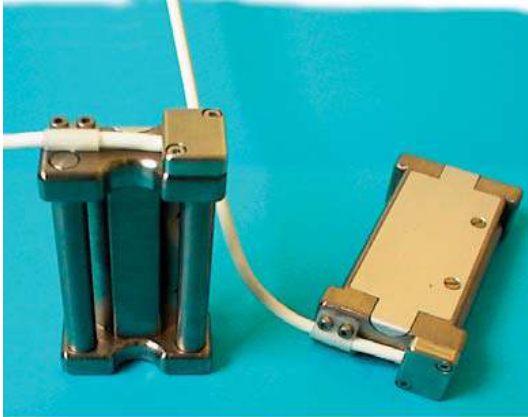

- Ultra rugged low-mass titanium design
- Seat belt restraint testing
- Tension only
- Replaceable cable

DESCRIPTION

Measurement Specialties has applied our decade of experience serving the automotive crash test industry to design the ultimate crash test seat belt restraint sensor. The EL20-S458 provides a super low mass titanium structure to minimize $F=MA$ errors during the crash event. All exterior surfaces are smoothed to prevent snagging on dummy or air bag materials; smoothed exterior profiles protect your expensive crash test dummy from damage while eliminating drag and frictional error. The EL20-S458 is offered with optional ultra low mass slotted titanium axles and super robust armoured cable exit from the device. The user-replaceable cable ensures that even if your cabling is damaged, replacement cables can be rapidly wired and your test facility remains in full operation at all times. The low noise Wheatstone bridge consists of metal foil strain gages which provide full scale outputs of typically 2 mV/V of excitation. The EL20-S458 is also available with internal linearization (Option B) to provide $\pm 0.5\%$ FS maximum nonlinearity. Option C provides linearization and high level output of 0.5 to 4.5 V. The EL20-S458 can be configured with a variety of options to fine tune the instrument to your application: select from several standard compensated temperature ranges, slotted or knurled axles, input voltages, lead lengths or specify unique combinations of these options. The EL20-S458 belt tension load cell can be fine-tuned to meet your crash test or military test needs.

FEATURES

- Super low mass titanium design : minimizes $F=MA$ errors in measurement
- Ultra low mass slotted titanium axles available
- 1KL (5KN) - 3.2KL (16KN) tension ranges
- Low noise
- Optional linearized and high level output
- Robust user replaceable cabling

APPLICATIONS

- Automotive crash test
- Military payload delivery
- Sport and military parachute tether loads
- Automatic reserve chute deployment systems

EL20-S458

STANDARD RANGES

Ranges		Overrange	Output "FSO" standard & B option (nom.)	Output "FSO" C option (nom.)	NL standard (%FSO)	NL B & C options (%FSO)	Thermal Zero Shift "TZS"
KN	KL						
5	1	2 x FS	1.5 mV/V	0.5 to 4.5 V	3 %	0.5 %	± 0.02% FSO /°C
16	3.2	1.5 x FS	2 mV/V	0.5 to 4.5 V	3 %	0.5 %	± 0.02% FSO /°C

PERFORMANCE SPECIFICATIONS

PARAMETERS	VALUES	NOTES
Supply voltage	10VDC	
Input resistance	350Ω nom. standard	
Output resistance	350Ω nom. standard & B option	
Electrical in	≤ 25mA B & C option	
Non-repeatability	± 0.25 % FSO	
Thermal Sensitivity Shift "TSS"	± 0.02% /°C	
Operating temperature	-40°C to 120°C	
Compensated temperature	0°C to 60°C	See option table for other temperatures
Zero offset at 23°C	± 2 % FSO standard & B option ; 500mV nom. C option	
CE conformance according to	EN 61010-1, EN 50081-1, 50082- EN 1	

EL20-S458

DIMENSIONS

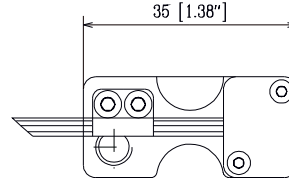
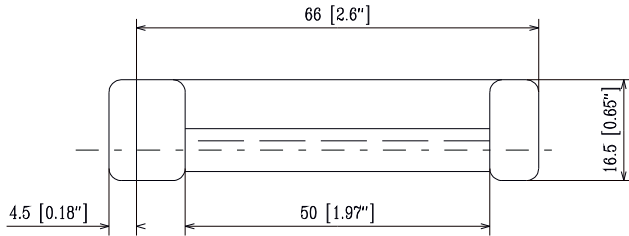

AXLES

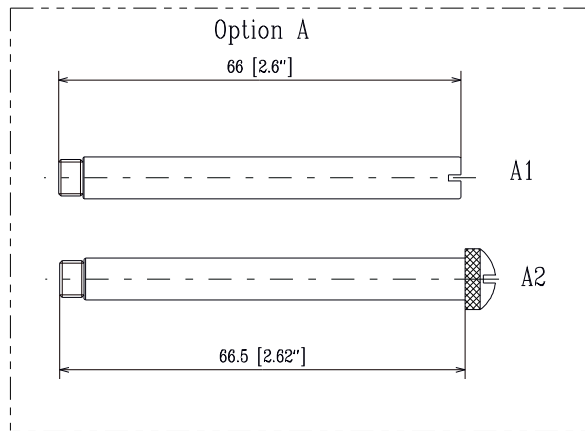
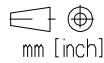
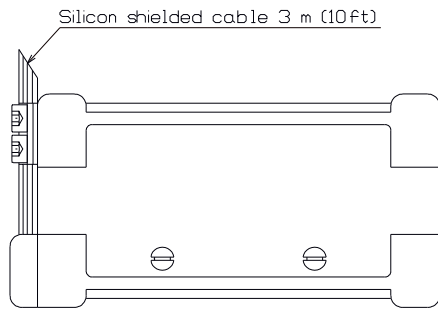

INSTALLATION

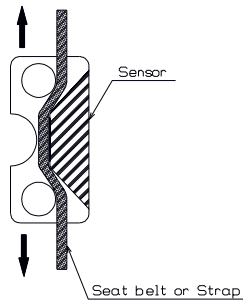

OPTION B

FSO (5KN): 1.5mV/V Electrical in : 25mA max.
 FSO (16KN): 2mV/V Electrical out : 3500hms nom.
 NL : $\pm 0.5\%FSO$

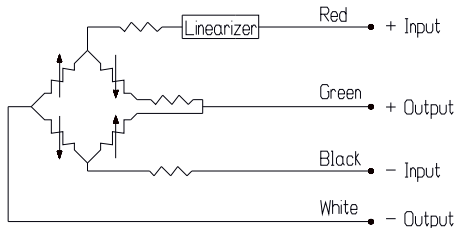

CONNECTIONS

Standard

FSO (5KN): 1.5mV/V Electrical in : 3500hms nom.
 FSO (16KN): 2mV/V Electrical out : 3500hms nom.
 NL : $\pm 3\%FSO$

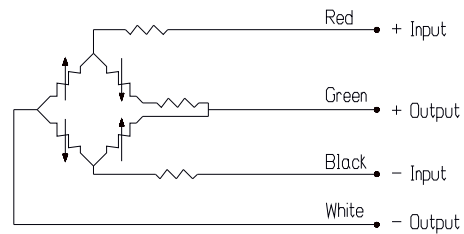

OPTION C

FSO : 0.5 to 4.5V Electrical in : 25 mA max.
 NL : $\pm 0.5\%FSO$ Electrical out : short circuit protected

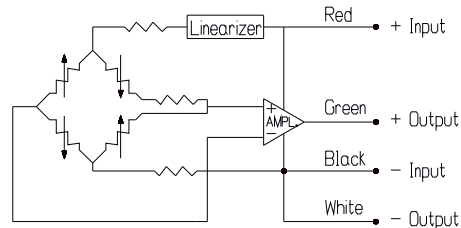

EL20-S458

OPTIONS AND ACCESSORIES

OPTIONS	CODES	DESCRIPTIONS
Compensated Temperature Ranges	Z0	-40°C to 20°C.
	Z1	-20°C to 40°C.
	Z*	Non-standard, contact MEAS.
Special Cable Length	L00F	Replace "00" with total length in feet Specified only on units with lbf range.
	L00M	Replace "00" with total length in meters Specified only on units with N range.
Axle	A1	Flush, low mass titanium axle.
	A2	Hand grip, knurled titanium axle (standard).
Amplified and Linearized Output	B	Linearized (unamplified) output (NL : +/-0.5% FS).
	C	Linearized (NL : +/-0.5% FS) high level output 0.5 to 4.5 V +/-3% span trim.
Adapter	SL1	Sleeve adapter for 38/42 mm (1.5 /1.65) strap width.
	SL2	Sleeve adapter for 28/32 mm (1.1 /1.26) strap width.
	SL3	Sleeve adapter for 24/28 mm (0.95 /1.1) strap width.

Notes: calibrations performed for endpoint nonlinearity: 0%, 20%, 40%, 60%, 80% and 100% FS input.

For special connectors/wiring and ID chips: contact factory sales representative.

ORDERING INFORMATION

Model	-	Body	-	Range & Unit		-	/Options
EL20	-	S458	-	5 KN 16 KN	1 KL 3.2 KL	-	/Z0, Z1 or Z* /L00F or L00M /A1 or A2 /B or C /SL1, SL2 or SL3 /AL

Example of model construction: EL20-S458-16KN-/Z1 /L3M/C

NORTH AMERICA

Measurement Specialties
45738 Northport Loop West
Fremont, CA 94538
Tel: 1-800-767-1888
Fax: 1-510-498-1578
Sales: pfg.cs.amer@meas-spec.com

EUROPE

Measurement Specialties
(Europe), Ltd.
26 Rue des Dames
78340 Les Clayes-sous-Bois, France
Tel: +33 (0) 130 79 33 00
Fax: +33 (0) 134 81 03 59
Sales: pfg.cs.emea@meas-spec.com

ASIA

Measurement Specialties
(China), Ltd.
No. 26 Langshan Road
Shenzhen High-Tech Park (North)
Nanshan District, Shenzhen 518107
China
Tel: +86 755 3330 5088
Fax: +86 755 3330 5099
Sales: pfg.cs.asia@meas-spec.com

The information in this sheet has been carefully reviewed and is believed to be accurate; however, no responsibility is assumed for inaccuracies. Furthermore, this information does not convey to the purchaser of such devices any license under the patent rights to the manufacturer. Measurement Specialties, Inc. reserves the right to make changes without further notice to any product herein. Measurement Specialties, Inc. makes no warranty, representation or guarantee regarding the suitability of its product for any particular purpose, nor does Measurement Specialties, Inc. assume any liability arising out of the application or use of any product or circuit and specifically disclaims any and all liability, including without limitation consequential or incidental damages. Typical parameters can and do vary in different applications. All operating parameters must be validated for each customer application by customer's technical experts. Measurement Specialties, Inc. does not convey any license under its patent rights nor the rights of others.