

3141 THRU 3144

Data Sheet
27621.6A*

SENSITIVE HALL-EFFECT SWITCHES FOR HIGH-TEMPERATURE OPERATION

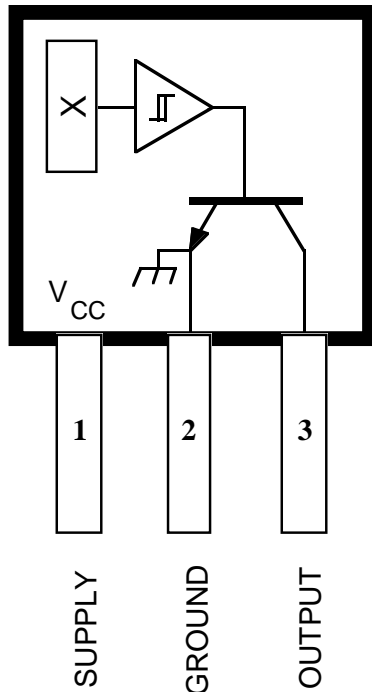

Dwg. PH-003A

Pinning is shown viewed from branded side.

ABSOLUTE MAXIMUM RATINGS at $T_A = +25^\circ\text{C}$

Supply Voltage, V_{CC}	28 V
Reverse Battery Voltage, V_{RCC}	-35 V
Magnetic Flux Density, B	Unlimited
Output OFF Voltage, V_{OUT}	28 V
Reverse Output Voltage, V_{OUT}	-0.5 V
Continuous Output Current, I_{OUT}	25 mA
Operating Temperature Range, T_A	
Suffix 'E-'	-40°C to +85°C
Suffix 'L-'	-40°C to +150°C
Storage Temperature Range, T_S	-65°C to +170°C

These Hall-effect switches are monolithic integrated circuits with tighter magnetic specifications, designed to operate continuously over extended temperatures to +150°C, and are more stable with both temperature and supply voltage changes. The unipolar switching characteristic makes these devices ideal for use with a simple bar or rod magnet. The four basic devices (3141, 3142, 3143, and 3144) are identical except for magnetic switch points.

Each device includes a voltage regulator for operation with supply voltages of 4.5 to 24 volts, reverse battery protection diode, quadratic Hall-voltage generator, temperature compensation circuitry, small-signal amplifier, Schmitt trigger, and an open-collector output to sink up to 25 mA. With suitable output pull up, they can be used with bipolar or CMOS logic circuits. The A3141- and A3142- are improved replacements for the UGN/UGS3140-; the A3144- is the improved replacement for the UGN/UGS3120-.

The first character of the part number suffix determines the device operating temperature range. Suffix 'E-' is for the automotive and industrial temperature range of -40°C to +85°C. Suffix 'L-' is for the automotive and military temperature range of -40°C to +150°C. Three package styles provide a magnetically optimized package for most applications. Suffix '-LT' is a miniature SOT89/TO-243AA transistor package for surface-mount applications; suffix '-U' is a three-lead plastic mini-SIP, while suffix '-UA' is a three-lead ultra-mini-SIP.

FEATURES and BENEFITS

- Superior Temp. Stability for Automotive or Industrial Applications
- 4.5 V to 24 V Operation ... Needs Only An Unregulated Supply
- Open-Collector 25 mA Output ... Compatible with Digital Logic
- Reverse Battery Protection
- Activate with Small, Commercially Available Permanent Magnets
- Solid-State Reliability
- Small Size
- Resistant to Physical Stress

Always order by complete part number, e.g., **A3141ELT**.

3141 THRU 3144

SENSITIVE HALL-EFFECT SWITCHES FOR HIGH-TEMP. OPERATION

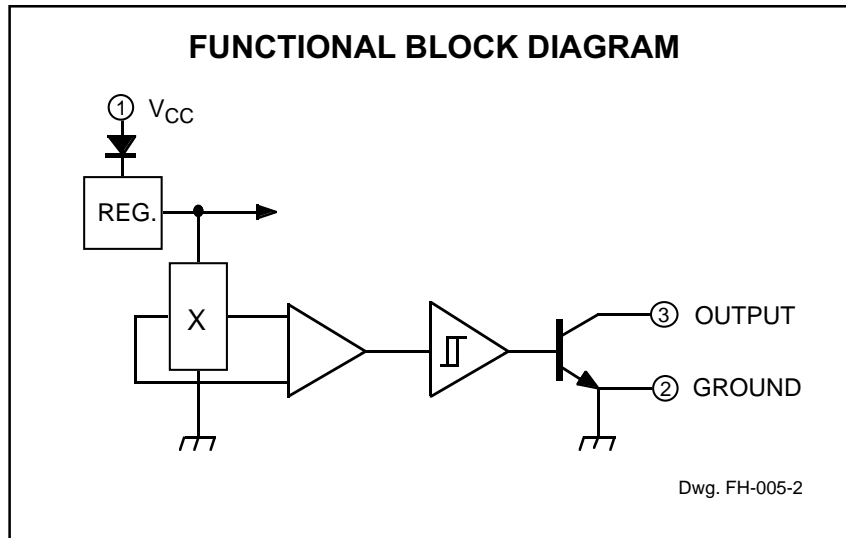

ELECTRICAL CHARACTERISTICS at $V_{CC} = 8\text{ V}$ over operating temperature range.

Characteristic	Symbol	Test Conditions	Limits			
			Min.	Typ.	Max.	Units
Supply Voltage	V_{CC}	Operating	4.5	—	24	V
Output Saturation Voltage	$V_{OUT(SAT)}$	$I_{OUT} = 20\text{ mA}$, $B > B_{OP}$	—	175	400	mV
Output Leakage Current	I_{OFF}	$V_{OUT} = 24\text{ V}$, $B < B_{RP}$	—	<1.0	10	μA
Supply Current	I_{CC}	$B < B_{RP}$ (Output OFF)	—	4.4	9.0	mA
Output Rise Time	t_r	$R_L = 820\ \Omega$, $C_L = 20\text{ pF}$	—	0.04	2.0	μs
Output Fall Time	t_f	$R_L = 820\ \Omega$, $C_L = 20\text{ pF}$	—	0.18	2.0	μs

MAGNETIC CHARACTERISTICS in gauss over operating supply voltage range.

Characteristic	Part Numbers*											
	A3141-			A3142-			A3143-			A3144-		
	Min.	Typ.	Max.	Min.	Typ.	Max.	Min.	Typ.	Max.	Min.	Typ.	Max.
B_{OP} at $T_A = 25^\circ\text{C}$	50	100	160	130	180	230	220	280	340	70	—	350
over operating temp. range	30	100	175	115	180	245	205	280	355	35	—	450
B_{RP} at $T_A = 25^\circ\text{C}$	10	45	130	75	125	175	165	225	285	50	—	330
over operating temp. range	10	45	145	60	125	190	150	225	300	25	—	430
B_{hys} at $T_A = 25^\circ\text{C}$	20	55	80	30	55	80	30	55	80	20	55	—
over operating temp. range	20	55	80	30	55	80	30	55	80	20	55	—

NOTES: Typical values are at $T_A = +25^\circ\text{C}$ and $V_{CC} = 8\text{ V}$.

B_{OP} = operate point (output turns ON); B_{RP} = release point (output turns OFF); B_{hys} = hysteresis ($B_{OP} - B_{RP}$).

1 gauss (G) is exactly equal to 0.1 millitesla (mT).

*Complete part number includes a suffix to identify operating temperature range (E- or L-) and package type (-LT, -U, or -UA).



115 Northeast Cutoff, Box 15036

SUNSTAR 传感与控制 <http://www.sensor-ic.com/> TEL: 0755-83376549 FAX: 0755-83376182 E-MAIL: szss20@163.com

Worcester, Massachusetts 01615-0036 (308) 653-5000
Copyright © 1993, 2002 Allegro MicroSystems, Inc.

3141 THRU 3144 SENSITIVE HALL-EFFECT SWITCHES FOR HIGH-TEMP. OPERATION

TYPICAL OPERATING CHARACTERISTICS

A3142- SWITCH POINTS

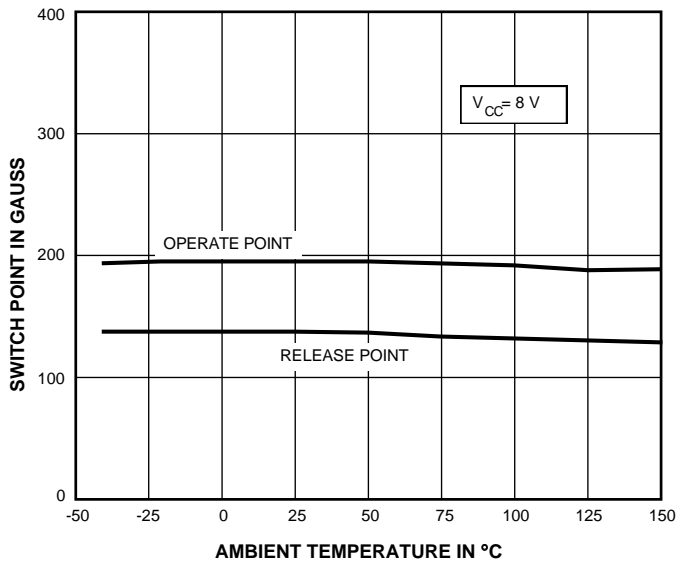

Dwg. GH-044

OUTPUT SATURATION VOLTAGE

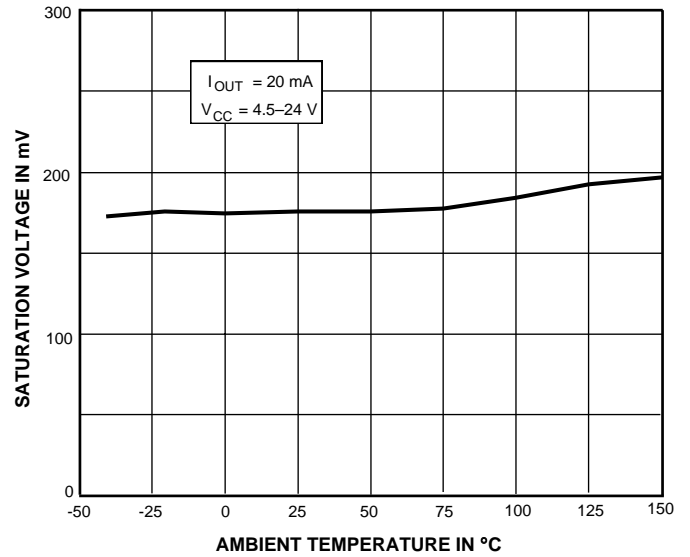

Dwg. GH-040-1

SUPPLY CURRENT

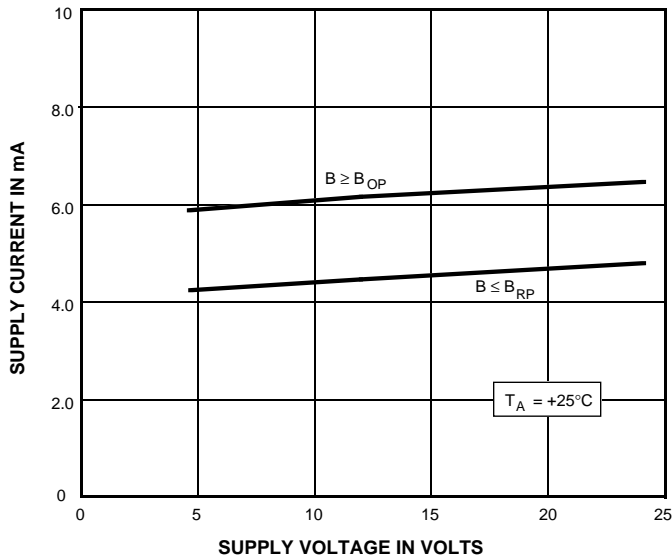

Dwg. GH-041-1

SUPPLY CURRENT

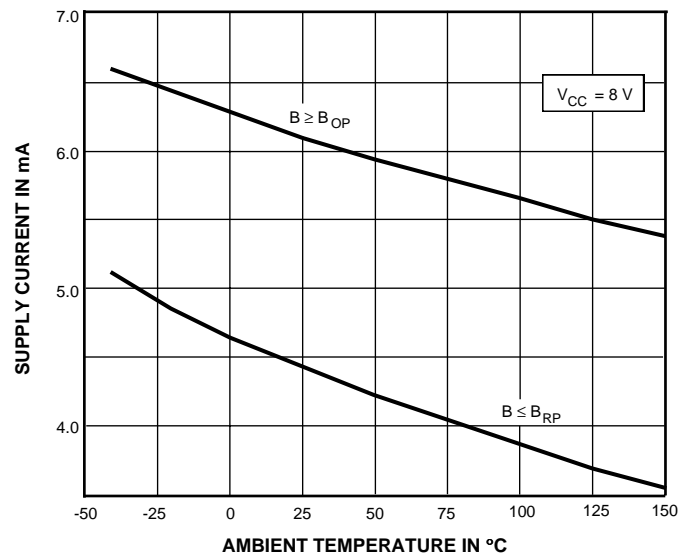

Dwg. GH-039-1

* Complete part number includes a suffix denoting operating temperature range (E- or L-) and package type (-LT, -U, or -UA).

3141 THRU 3144

SENSITIVE HALL-EFFECT SWITCHES FOR HIGH-TEMP. OPERATION

SENSOR LOCATIONS

(±0.005" [0.13 mm] die placement)

Suffix "LT"

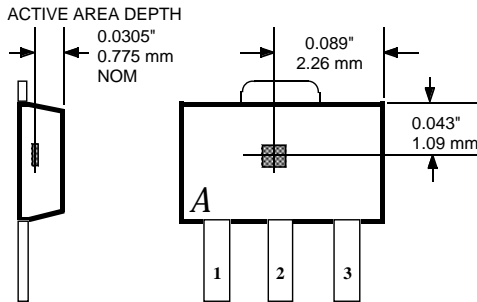

Dwg. MH-008-2D

Suffix "U"

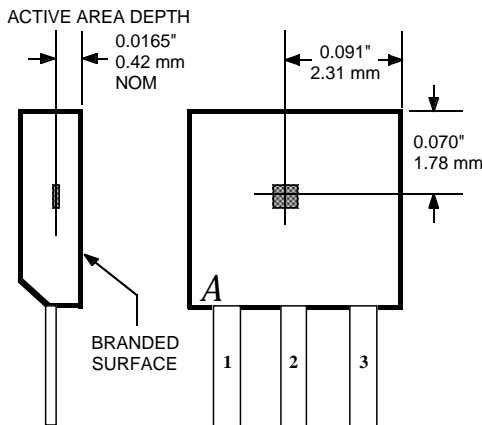

Dwg. MH-002-2C

Suffix "UA"

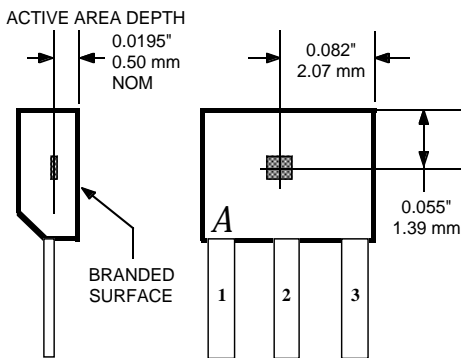

Dwg. MH-011-10A

TYPICAL OPERATING CHARACTERISTICS (cont.)

CHANGE IN OPERATE POINT

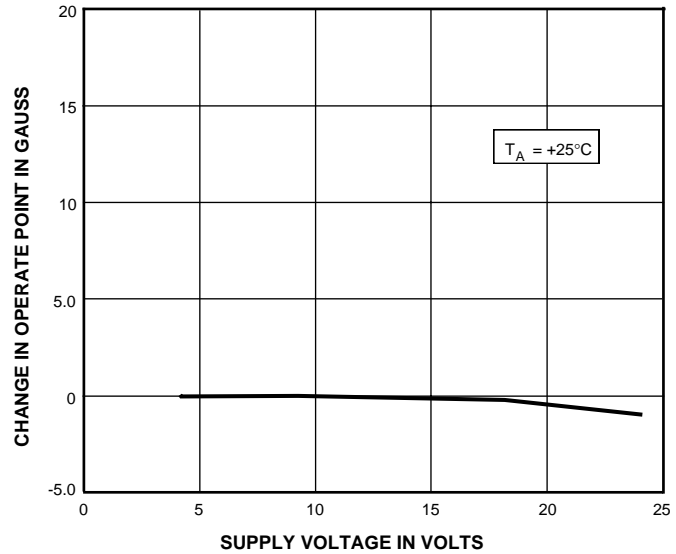

Dwg. GH-042-1

OPERATION

The output of these devices (pin 3) switches low when the magnetic field at the Hall sensor exceeds the operate point threshold (B_{OP}). At this point, the output voltage is $V_{OUT(SAT)}$. When the magnetic field is reduced to below the release point threshold (B_{RP}), the device output goes high. The difference in the magnetic operate and release points is called the hysteresis (B_{hys}) of the device. This built-in hysteresis allows clean switching of the output even in the presence of external mechanical vibration and electrical noise.

Extensive applications information for Hall-effect sensors is available in:

- *Hall-Effect IC Applications Guide*, Application Note 27701;
- *Hall-Effect Devices: Soldering, Gluing, Potting, Encapsulating, and Lead Forming*, Application Note 27703.1;
- *Soldering of Through-Hole Hall-Sensor Devices*, Application Note 27703; and
- *Soldering of Surface-Mount Hall-Sensor Devices*, Application Note 27703.2.

All are provided in *Allegro Electronic Data Book*, AMS-702. or at

www.allegromicro.com

3141 THRU 3144 SENSITIVE HALL-EFFECT SWITCHES FOR HIGH-TEMP. OPERATION

PACKAGE DESIGNATOR 'LT' (SOT89/TO-243AA)

Dimensions in Inches
(for reference only)

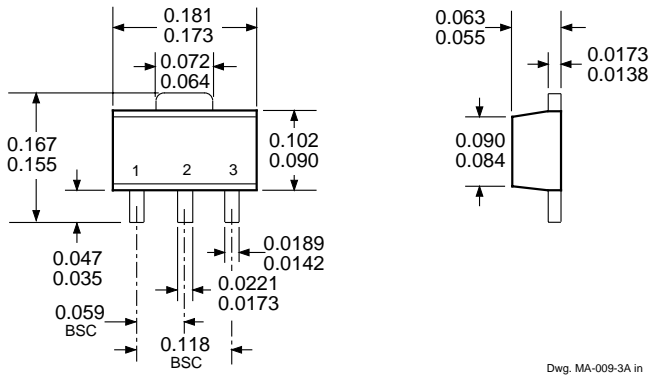

Dimensions in Millimeters
(controlling dimensions)

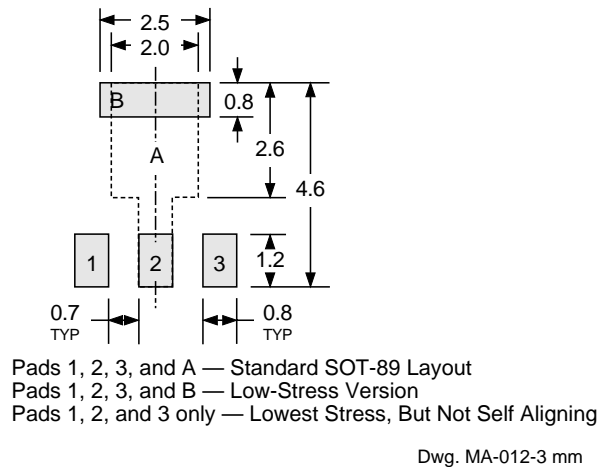
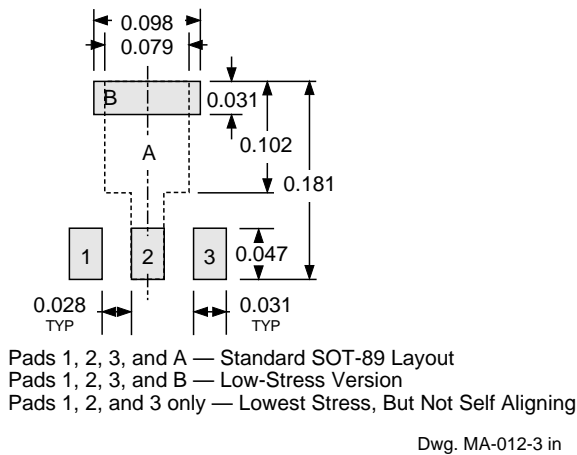
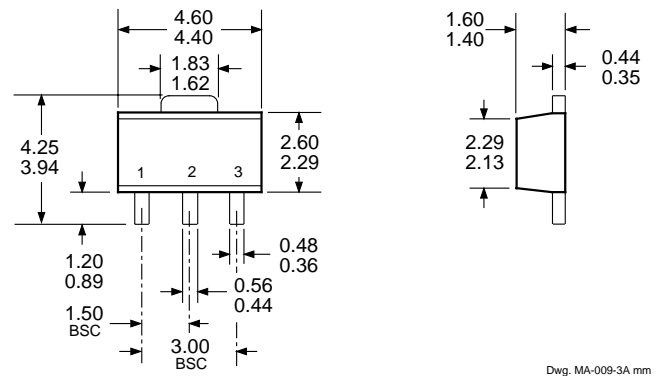

- NOTES: 1. Exact body and lead configuration at vendor's option within limits shown.
 2. Supplied in bulk pack (500 pieces per bag) or add "TR" to part number for tape and reel.

3141 THRU 3144
SENSITIVE
HALL-EFFECT SWITCHES
FOR HIGH-TEMP. OPERATION

PACKAGE DESIGNATOR 'U'

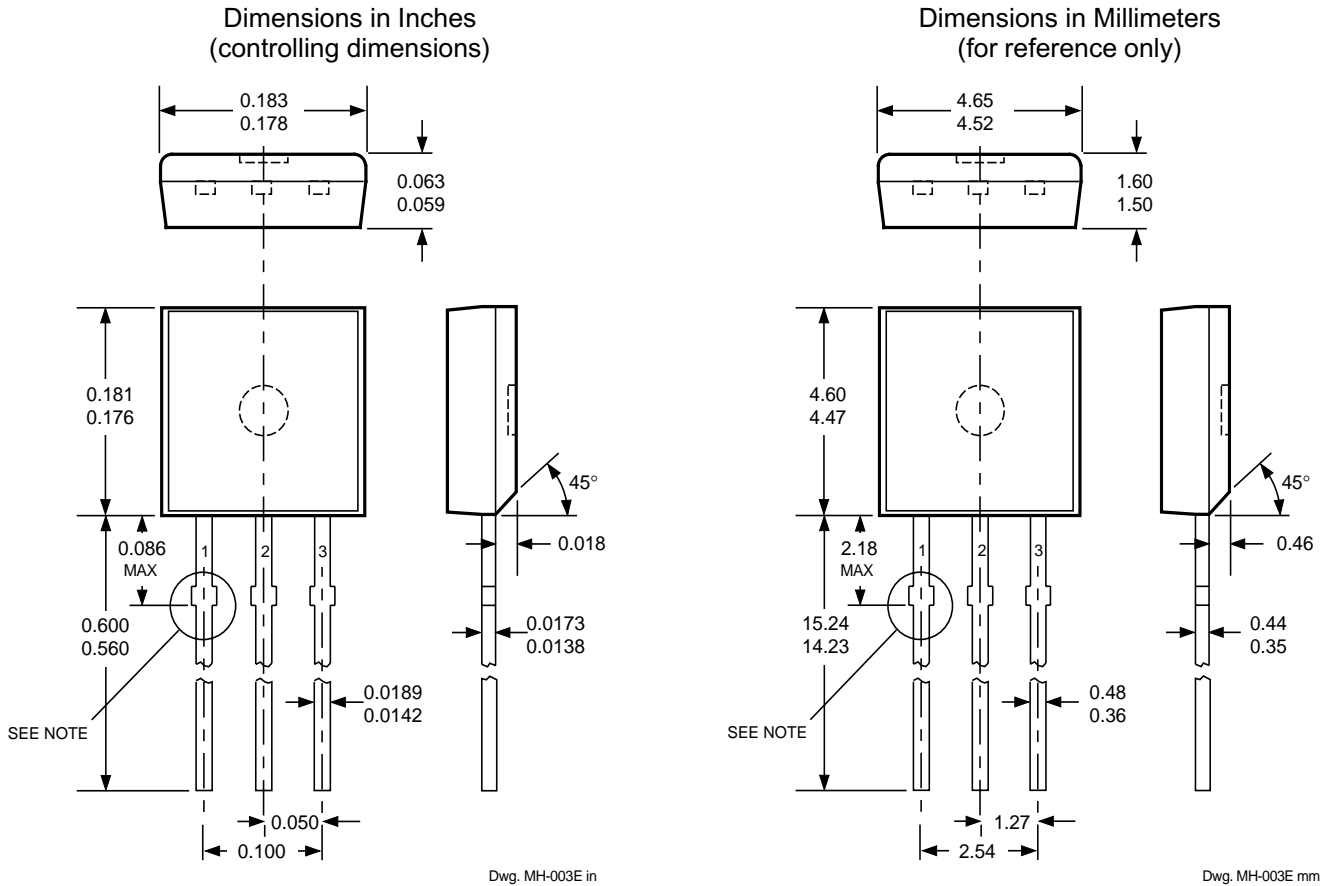

Devices in the 'U' package are NOT RECOMMENDED FOR NEW DESIGN

- NOTES: 1. Tolerances on package height and width represent allowable mold offsets. Dimensions given are measured at the widest point (parting line).
2. Exact body and lead configuration at vendor's option within limits shown.
3. Height does not include mold gate flash.
4. Recommended minimum PWB hole diameter to clear transition area is 0.035" (0.89 mm).

3141 THRU 3144 SENSITIVE HALL-EFFECT SWITCHES FOR HIGH-TEMP. OPERATION

PACKAGE DESIGNATOR 'UA'

Dimensions in Inches
(controlling dimensions)

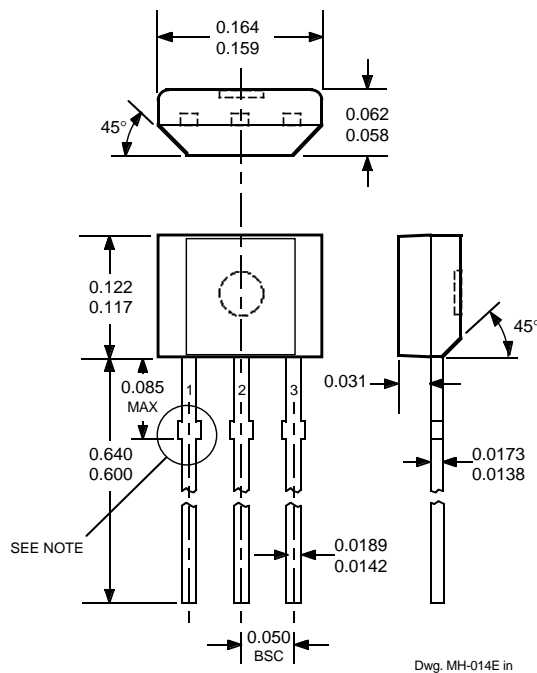

Dimensions in Millimeters
(for reference only)

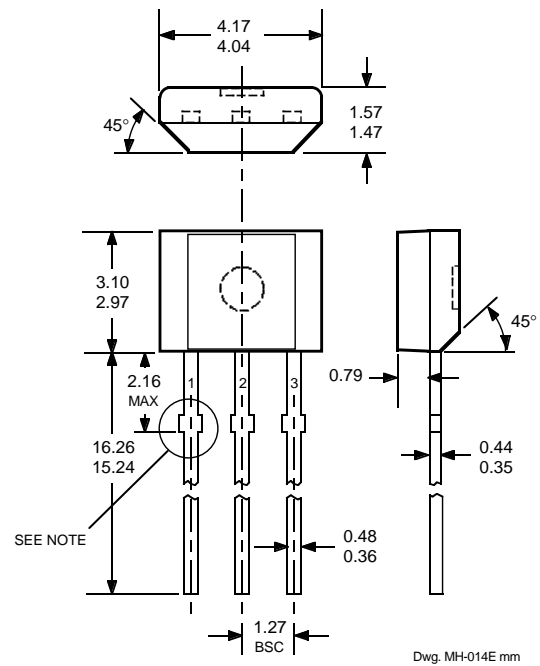

- NOTES: 1. Tolerances on package height and width represent allowable mold offsets. Dimensions given are measured at the widest point (parting line).
2. Exact body and lead configuration at vendor's option within limits shown.
3. Height does not include mold gate flash.
4. Supplied in bulk pack (500 pieces per bag).

The products described herein are manufactured under one or more of the following U.S. patents: 5,045,920; 5,264,783; 5,442,283; 5,389,889; 5,581,179; 5,517,112; 5,619,137; 5,621,319; 5,650,719; 5,686,894; 5,694,038; 5,729,130; 5,917,320; and other patents pending.

Allegro MicroSystems, Inc. reserves the right to make, from time to time, such departures from the detail specifications as may be required to permit improvements in the performance, reliability, or manufacturability of its products. Before placing an order, the user is cautioned to verify that the information being relied upon is current.

Allegro products are not authorized for use as critical components in life-support appliances, devices, or systems without express written approval.

The information included herein is believed to be accurate and reliable. However, Allegro MicroSystems, Inc. assumes no responsibility for its use; nor for any infringements of patents or other rights of third parties that may result from its use.

3141 THRU 3144

SENSITIVE HALL-EFFECT SWITCHES FOR HIGH-TEMP. OPERATION

HALL-EFFECT SENSORS

UNIPOLEAR HALL-EFFECT DIGITAL SWITCHES						
Partial Part Number	Operate Point (G) Over Oper. Voltage & Temp. Range	Release Point (G) Voltage & Temp. Range	Hysteresis (G) Temp. Range	Oper. Temp.	Packages	Replaces and Comments
A3121x	220 to 500	80 to 410	60 to 150	E, L	LT, UA	3019, 3113, 3119
A3122x	260 to 430	120 to 360	70 to 140	E, L	LT, UA	
A3123x	230 to 470	160 to 330	70 to 140	E, L	LT, UA	
A3141x	30 to 175	10 to 145	20 to 80	E, L	LT, UA	3040, 3140
A3142x	115 to 245	60 to 190	30 to 80	E, L	LT, UA	
A3143x	205 to 355	150 to 300	30 to 80	E, L	LT, UA	
A3144x	35 to 450	25 to 430	>20	E, L	LT, UA	3020, 3120
A3161E	<160 (Typ 130)	>30 (Typ 110)	5 to 80	E	LT, UA	2-wire operation
A3240x	<50 (Typ 35)	>5 (Typ 25)	Typ 10	E, L	LH, LT, UA	chopper stabilized
A3361E	<125	>40	5 to 30	E	LH, LT, UA	2-wire, chopper stabilized, output normally high
A3362E	<125	>40	5 to 30	E	LH, LT, UA	2-wire, chopper stabilized, output normally low
MICROPOWER OMNIPOLAR HALL-EFFECT DIGITAL SWITCHES						
Partial Part Number	Operate Points (G) Over Oper. Voltage & Temp. Range	Release Points (G) Voltage & Temp. Range	Hysteresis (G) Temp. Range	Oper. Temp.	Packages	Average Supply Current (μ A)
A3209E	>-60, <60	<-5, >5	Typ 7.7	E	LH, UA	<425 (Typ 145)
A3210E	>-60, <60	<-5, >5	Typ 7.7	E	LH, UA	<60 (Typ 8.8)
A3212E	>-55, <55	<-10, >10	Typ. 8	E	LH, UA	<10 (Typ 4.2)
BIPOLAR HALL-EFFECT DIGITAL SWITCHES						
Partial Part Number	Operate Point (G) Over Oper. Voltage & Temp. Range	Release Point (G) Voltage & Temp. Range	Hysteresis (G) Temp. Range	Oper. Temp.	Packages	Replaces and Comments
UGx3132	<95 (Typ 32)	>-95 (Typ -20)	>30 (Typ 52)	K, L, S	LT, UA	3030, 3130, 3131
UGx3133	<75 (Typ 32)	>-75 (Typ -20)	>30 (Typ 52)	K, L, S	LT, UA	
UGx3134	-40 to 50	-50 to 40	5 to 55	E, L	LT, UA	
A3260x	<30 (Typ 10)	>-30 (Typ -10)	Typ 20	E, L	LH, LT, UA	2 wire, chopper stabilized

Notes: 1) Typical data is at $T_A = +25^\circ\text{C}$ and nominal operating voltage.

2) "x" = Operating Temperature Range [suffix letter or (prefix)]: S (UGN) = -20°C to $+85^\circ\text{C}$, E = -40°C to $+85^\circ\text{C}$, J = -40°C to $+115^\circ\text{C}$, K (UGS) = -40°C to $+125^\circ\text{C}$, L (UGL) = -40°C to $+150^\circ\text{C}$.



欢迎索取免费详细资料、设计选型指南和光盘、样品；产品繁多未能尽录，欢迎来电查询。

[中国传感器科技信息网：HTTP://WWW.SENSOR-IC.COM/](http://WWW.SENSOR-IC.COM/)

[工控安防网：HTTP://WWW.PC-PS.NET/](http://WWW.PC-PS.NET/)

[消费电子专用电路网：HTTP://WWW.SUNSTARE.COM/](http://WWW.SUNSTARE.COM/)

E-MAIL：xjr5@163.com szss20@163.com

MSN：suns8888@hotmail.com

QQ：195847376

地址：深圳市福田区福华路福庆街鸿图大厦 1602 室

电话：0755-83376549 83376489 83387030 83387016

传真：0755-83376182 83338339 邮编：518033 手机：(0)13902971329

深圳展销部：深圳华强北路赛格电子市场 2583 号 TEL/FAX：
0755-83665529 25059422

北京分公司：北京海淀区知春路 132 号中发电子大厦 3097 号

TEL：010-81159046 82615020 13501189838 FAX：010-82613476

上海分公司：上海市北京东路 668 号上海赛格电子市场 2B35 号

TEL：021-28311762 56703037 13701955389 FAX：021-56703037

西安分公司：西安高新开发区 20 所(中国电子科技集团导航技术研究所)
西安劳动南路 88 号电子商城二楼 D23 号

TEL：029-81022619 13072977981 FAX:029-88789382

成都：TEL:(0)13717066236

技术支持：0755-83394033 13501568376

SUNSTAR商斯达实业集团是集研发、生产、工程、销售、代理经销、技术咨询、信息服务等为一体的高科技企业，是专业高科技电子产品生产厂家，是具有 10 多年历史的专业电子元器件供应商，是中国最早和最大的仓储式连锁规模经营大型综合电子零部件代理分销商之一，是一家专业代理和分销世界各大品牌 IC 芯片和电子元器件的连锁经营综合性国际公司。在香港、北京、深圳、上海、西安、成都等全国主要电子市场设有直属分公司和产品展示展销窗口门市部专卖店及代理分销商，已在全国范围内建成强大统一的供货和代理分销网络。我们专业代理经销、开发生产电子元器件、集成电路、传感器、微波光电元器件、工控机/DOC/DOM 电子盘、专用电路、单片机开发、MCU/DSP/ARM/FPGA 软件硬件、二极管、三极管、模块等，是您可靠的一站式现货配套供应商、方案提供商、部件功能模块开发配套商。专业以现代信息产业（计算机、通讯及传感器）三大支柱之一的传感器为主营业务，专业经营各类传感器的代理、销售生产、网络信息、科技图书资料及配套产品设计、工程开发。我们的专业网站——中国传感器科技信息网（全球传感器数据库）www.SENSOR-IC.COM 服务于全球高科技生产商及贸易商，为企业科技产品开发提供技术交流平台。欢迎各厂商互通有无、交换信息、交换链接、发布寻求代理信息。欢迎国外高科技传感器、变送器、执行器、自动控制产品厂商介绍产品到中国，共同开拓市场。本网站是关于各种传感器-变送器-仪器仪表及工业自动化大型专业网站，深入到工业控制、系统工程计 测量、自动化、安防报警、消费电子等众多领域，把最新的传感器-变送器-仪器仪表买卖信息，最新技术供求，最新采购商，行业动态，发展方向，最新的技术应用和市场资讯及时的传递给广大科技开发、科学研究、产品设计人员。本网站已成功为石油、化工、电力、医药、生物、航空、航天、国防、能源、冶金、电子、工业、农业、交通、汽车、矿山、煤炭、纺织、信息、通信、IT、安防、环保、印刷、科研、气象、仪器仪表等领域从事科学研究、产品设计、开发、生产制造的科技人员、管理人员、和采购人员提供满意服务。我们公司专业生产、代理、经销、销售各种传感器、变送器、敏感元器件、开关、执行器、仪器仪表、自动化控制系统：专门从事设计、生产、销售各种传感器、变送器、各种测控仪表、热工仪表、现场控制器、计算机控制系统、数据采集系统、各类环境监控系统、专用控制系统应用软件以及嵌入式系统开发及应用等工作。如热敏电阻、压敏电阻、温度传感器、温度变送器、湿度传感器、湿度变送器、气体传感器、气体变送器、压力传感器、压力变送、称重传感器、物（液）位传感器、物（液）位变送器、流量传感器、流量变送器、电流（压）传感器、溶氧传感器、霍尔传感器、图像传感器、超声波传感器、位移传感器、速度传感器、加速度传感器、扭距传感器、红外传感器、紫外传感器、火焰传感器、激光传感器、振动传感器、轴角传感器、光电传感器、接近传感器、干簧管传感器、继电器传感器、微型电泵、磁敏（阻）传感器、压力开关、接近开关、光电开关、色标传感器、光纤传感器、齿轮测速传感器、时间继电器、计数器、计米器、温控仪、固态继电器、调压模块、电磁铁、电压表、电流表等特殊传感器。同时承接传感器应用电路、产品设计和自动化工程项目。

更多产品请看本公司产品专用销售网站：

商斯达中国传感器科技信息网：<http://www.sensor-ic.com/>

商斯达工控安防网：<http://www.pc-ps.net/>

商斯达电子元器件网：<http://www.sunstare.com/>

商斯达微波光电产品网：[HTTP://www.rfoe.net/](http://www.rfoe.net/)

商斯达消费电子产品网：<http://www.icasic.com/>

商斯达军工产品网：<http://www.junpinic.com/>

商斯达实业科技产品网：<http://www.sunstars.cn/> 传感器销售热线：

地址：深圳市福田区福华路福庆街鸿图大厦 1602 室

电话：0755-83607652 83376489 83376549 83370250 83370251 82500323

传真：0755-83376182 (0) 13902971329 MSN: SUNS888@hotmail.com

邮编：518033 E-mail: szss20@163.com QQ: 195847376

深圳赛格展销部：深圳华强北路赛格电子市场 2583 号 电话：0755-83665529 25059422

技术支持：0755-83394033 13501568376

欢迎索取免费详细资料、设计指南和光盘；产品凡多，未能尽录，欢迎来电查询。

北京分公司：北京海淀区知春路 132 号中发电子大厦 3097 号

TEL: 010-81159046 82615020 13501189838 FAX: 010-62543996

上海分公司：上海市北京东路 668 号上海赛格电子市场 D125 号

TEL: 021-28311762 56703037 13701955389 FAX: 021-56703037

西安分公司：西安高新开发区 20 所(中国电子科技集团导航技术研究所)

西安劳动南路 88 号电子商城二楼 D23 号

TEL: 029-81022619 13072977981 FAX:029-88789382